



Konfor Sınıfı Muavin Koltuğu
Comfort Class Guide Seat
Beifahrersitz in der Komfortklasse

OPTIMA
GUIDE









M3 / M2







KOLTUK ÖZELLİKLERİ

	KOLTUK MODELİ Tekli Koltuk
	ÖLÇÜLER Oturak Geniřlięi Oturak Derinlięi
	FONKSİYON Yukarı Katlanır Oturak
	EMNİYET KEMER SİSTEMİ 3 Noktalı Emniyet Kemerı
	KOLÇAK Yukarı Katlanır Kolçak
	DİĞER AKSESUARLAR Oturak Kilit Sistemi
	AĞIRLIK

PRODUCT OVERVIEW

	SEAT TYPES Single Seat
	DIMENSIONS Cushion Width Cushion Length
	FEATURES Foldable (Up) Cushion
	SECURITY BELT SYSTEM 3-point Seat Belt
	ARMREST Foldable Armrest (Up)
	FURTHER ACCESSORIES Foldable Cushion Lock System
	WEIGHT

PRODUKTÜBERSICHT

	SITZMODELLE Einzelsitz	<input checked="" type="checkbox"/>
	ABMESSUNGEN Sitzkissenbreite Sitzkissenlänge	420 mm 420 mm
	FUNKTIONEN Klappbarer Sitzkissen	<input checked="" type="checkbox"/>
	SICHERHEITSGURT 3 Punkt Gurt	<input checked="" type="checkbox"/>
	ARMLEHNEN klappbar nach oben	<input checked="" type="checkbox"/>
	WEITERE ZUBEHÖRTEILE Sitz Klappschloss	<input type="checkbox"/>
	GEWICHT	17 kg

Standart / Standard / Standard Opsiyonel / Option / Option



Yukarı Katlanır Oturak
Foldable (Up) Cushion
Klappbarer Sitzkissen

Oturak Kilit Sistemi
Foldable Cushion Lock System
Sitz Klappschloss

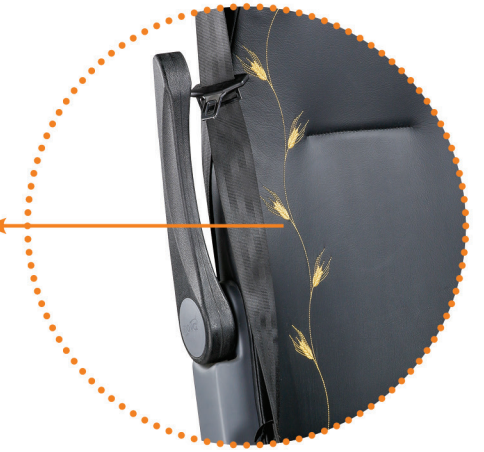

Yukarı Katlanır Kolçak
Foldable Armrest (Up)
klappbar nach oben

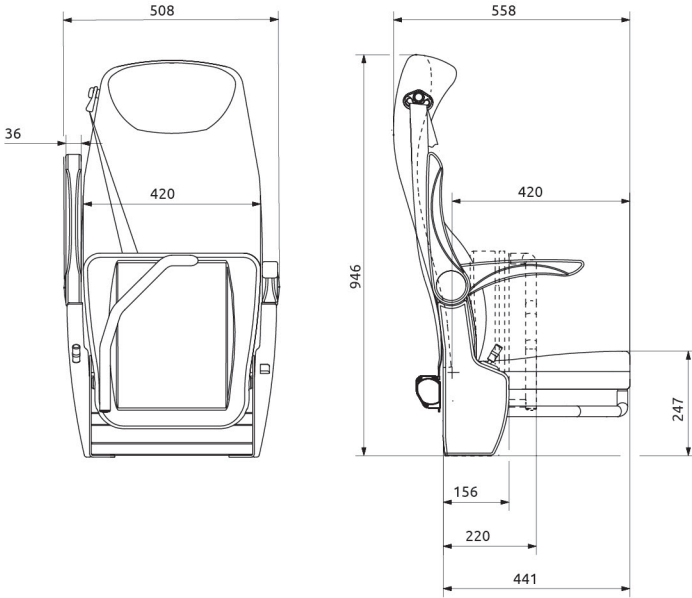

Uygun olunan standartlar
Complies with legal requirements
Entspricht den gesetzlichen Normen

ECE R14/ ECE R118

